

Catalog of hardware and accessories 2006

CONTROL HORNS **NEW**

TOWING - HARDWARE

CONTROL LEVERS

POWER CONNECTORS

PUSHRODS, CLEVIS

CONTROL LINES MODELS 

HINGES **NEW**

ENGINE MOUNTING HARDWARE **NEW**

HARDWARE **NEW**

FUEL TANK, PUMP, HARDWARE **NEW**

LATCHES **NEW**

BATTERY COMPARTMENTS

PROPELLER Aero

SURFACE SERVO COVERS **NEW**

Boat

TRANSMITTER TRAY **NEW**

PROP SPINNERS

WORK - TOOLS

WHEELS, UNDERCARRIAGE **NEW**

PILOT BUSTS

NYLON RIBS

WOOD PRODUCTION

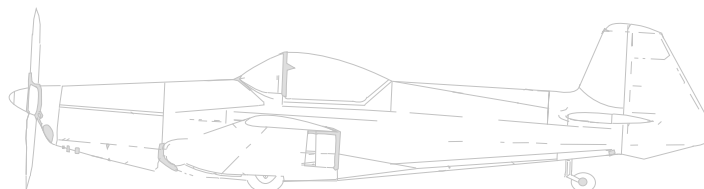

CONTROL HORNS



Description:

Control horn 18 mm
Mounting set incl. hardware(screws).

Item No.:0123109

2 sets/bag

Item No.:0123104

only nylon part 2 pc/loose

Description:

Fiberglass's lever for aileron
size 18mm

Item No.:0123110

1 pc/loose

Item No.:0123113

10 pc/bag



Description:

Control horn 31 mm

Item No.:0123111

Mounting Set 2 pc. incl. screw.

Item No.:0123103

only nylon part 2 pc/loose

Description:

Slow Flyer Control horn D.0,8mm

Item No.:0123105 - 10 pc./ bag with label

Item No.:0123108 - 1 pc. - losely packed

Description:

Slow Flyer Control horn D.1,0mm

Item No.:0123106 - 10 pc./ bag with label

Item No.0123107 - 1 pc. - losely packed



CONTROL LEVERS



Description:

Steering arm 0° for 2.6 mm Dia
set 2 pc.+Mount.Hardware

Item No.:0123115 set 2 pc.+Mount.Hardware/bag

Item No.:0123100 1 pc /loose

Description:

Steering arm 180° for 4mm Dia
set 2 pc.+ Mount hardware/bag

Item No.:0123116

Item No.:0123101 1 pc /loose



Description:

Nylon lever set 180° with bearing
set 2 pc.+ Mounting hardware/bag

Item No.:0123114

Description:

Lever 120° with bearing
set 2 pc.+ Mount. Hardware / bag

Item No.:0123119





Description:

Aileron bellcrank 90/120° with bearing.
Set 2 pc. incl. Moun hardware/bag

Item No.:0123117

Description:

Lever 90° with bearing
set 2 pc.+ Mount. Hardware /bag

Item No.:0123118



Description:

Bellcrank for pendulum

Item No.:0123112

2 Pc./bag

Item No.:0123102

1 Pc./lose

Description:

Boat Rudder

Item No.:0122900 1 Pc./bag

Item No.:0122902 1 Pc./loose

Description:

Boat Rudder incl. tiller arm

Item No.:0122901 1 set/bag

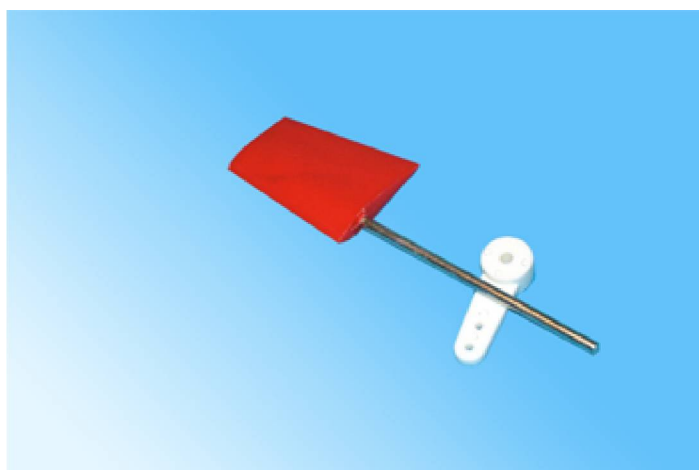

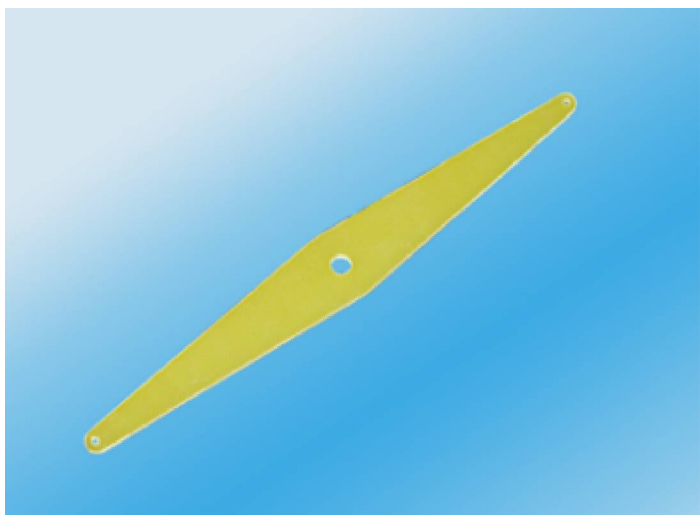

Description:

Arms for "T" stabilizer
Fiberglass 1,5 mm

Item No.:

0123121	1 pc. / loose
0123122	2 pc. / bag

PUSHRODS, CLEVIS

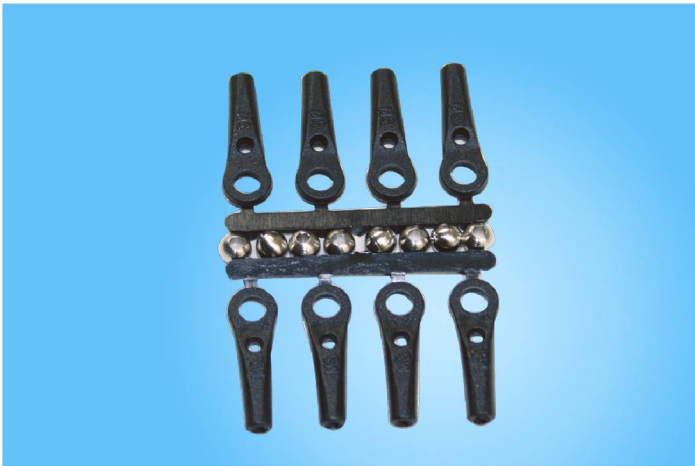

Description:

Ball - link M2-M2,5 extra reinforced incl. ball

Item No.:0123606

1 pc. nylon part only/loose

Item No.:0123607

Set 8 pc./bag

Description:

Ball - link M3 with metal ball

Dia 5.5/M3

Item No.:0123601 Set 6 pc./bag

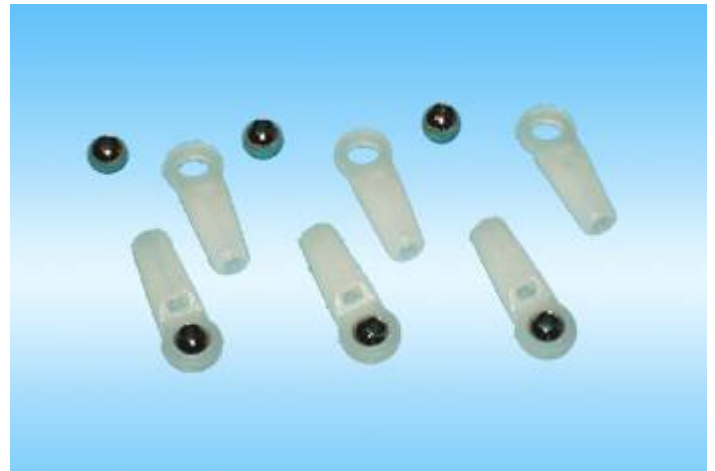

Description:

Ball - link with ball M2 - M2,5 set

Item No.:0123605

Description:

Ball - link with ball M2

Item No.:0123605 Set 8 Pc/ bag

Item No.: 0123604 Set 4 Pc only Nylon clevis/loose



Description:

Pushrod retainer for wire 1.2mm Dia

Item No.:0123808 mount. set 10 pc.

Item No.:0123809 14 Pc Nylon part only /loose



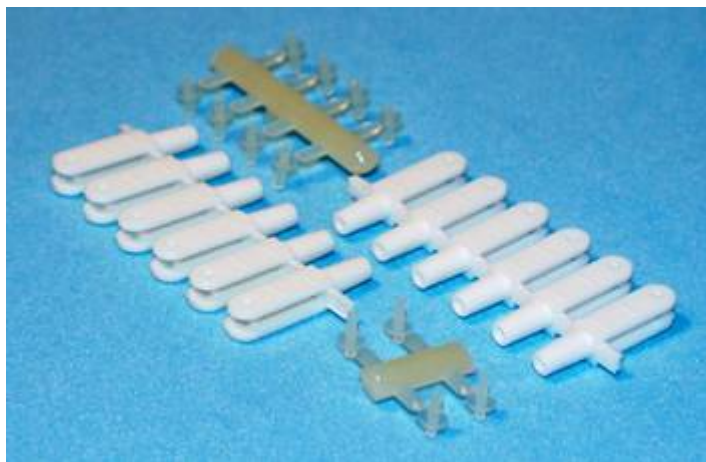

Description:

Nylon clevis M2 W/pins

Item No.:0123704 set 12 pc.

Item No.:0123705 Nylon clevis 1 Pc/ bag

Description:

Clevis W/pins
(to connect the ailerons horn set to the clevis)

Item No.:0123910 set 8 pc/bag

Item No.:0123911 1 pc./loose.

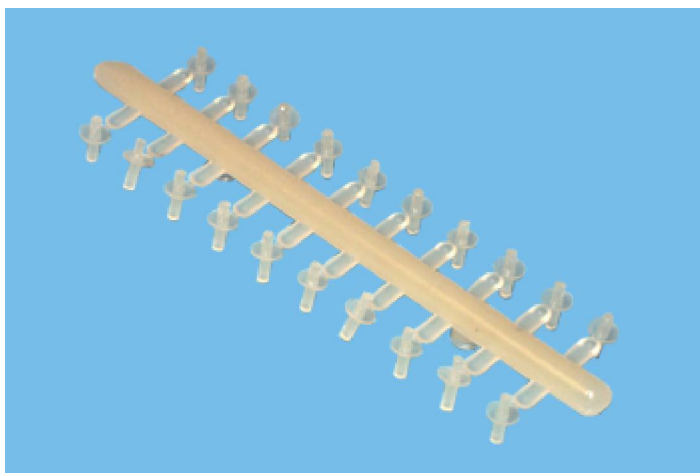
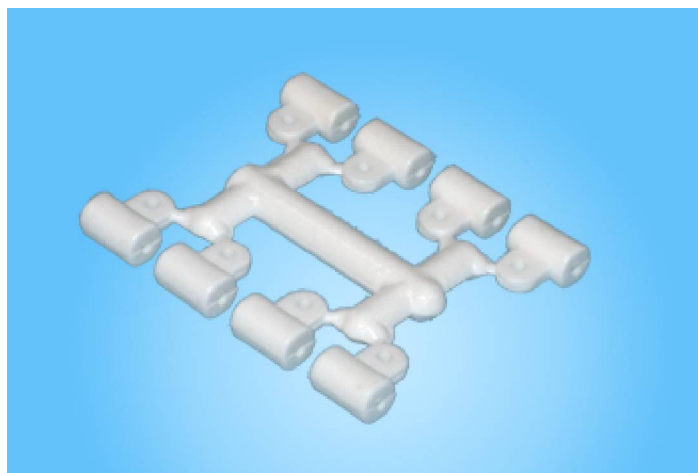

Description:

Nylon Clevis pins

Item No.:0123702 set 20 pc/bag

Description:

Pushrods connector M2
set with peg,washers, nut
Item No.:0202221 2 set/bag

Item No.:0202220

Pushrods connector M2 only peg/loose



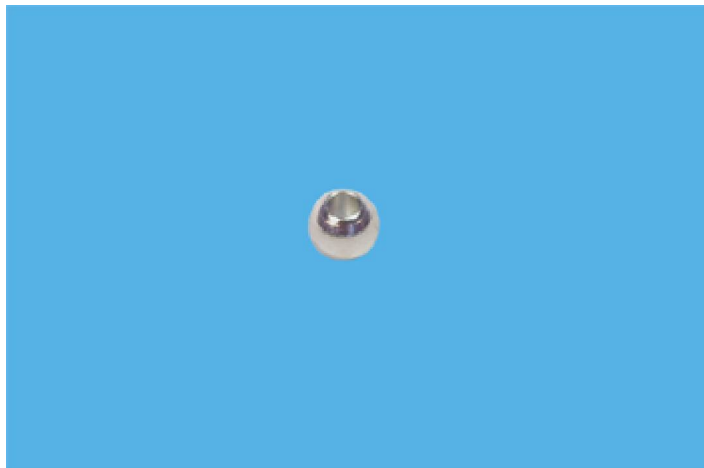

Description: Ball for peg M2

Item No.: 0205200

1 pc/loose

Item No.: 0205205

5 pc/bag

Description: Ball M2 with thread

Item No.: 0205210

1 pc/loose

Item No.: 0205215

5 pc/bag

Description: Ball for peg 5,5 mm Dia.

Item No. : 0205220

1 pc/loose

Description:

Metal clevis with M2 thread

Item No.: 0237200 1 pc/loose

Item No.: 0237210 6 pc/bag

Metal clevis with M3 thread

Item No.: 0237300 1 pc/loose

Item No.: 0237301 6 pc/bag



Description:

Threaded couplers M2 for solderable

Item No. 0222200

1 pc/loose

Item No.: 0222210

10 pc/bag

Description:

Threaded ball for peg M2.

Item No. 0205210 1 pc/loose

Item No.: 0205210 5 pc/bag

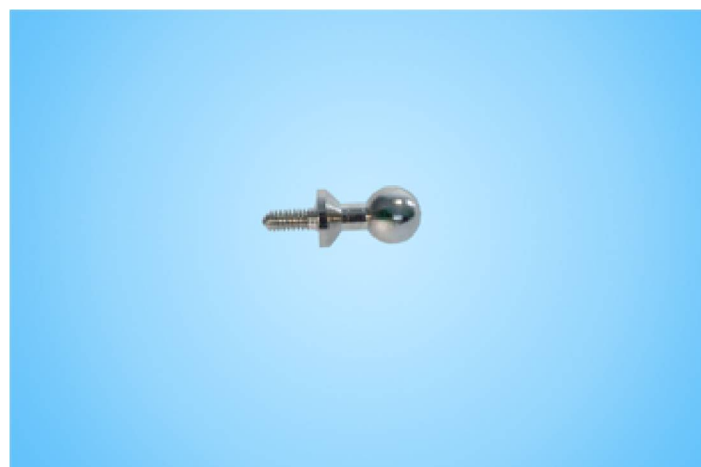

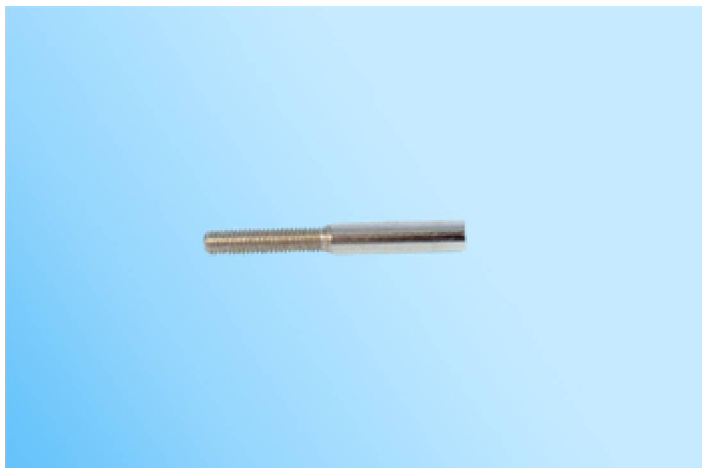

Description:
Threaded couplers M3 for solderable

Item No. 0222300 1 pc/loose
Item No.: 0222301 10 pc/bag

Description:
Threaded couplers M2 for solderable
with groove

Item No. 0222201 1 pc/loose
Item No.: 0222211 10 pc/bag

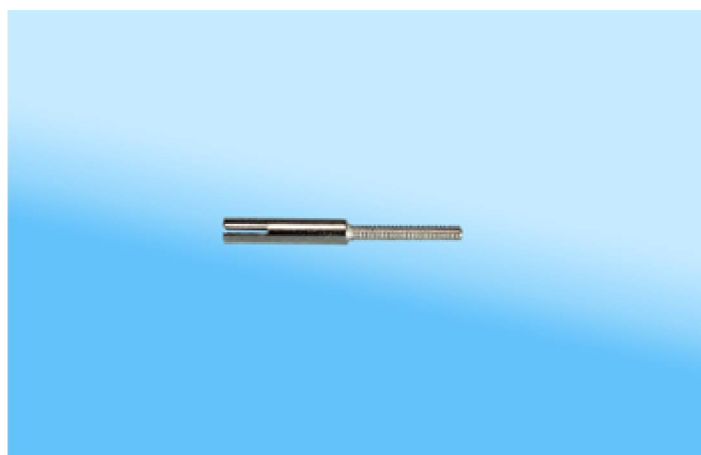

HINGES



Description:

Plug hinge for giant planes-,5 mm Dia.

Material : reinforced Nylon. Extreme strong.

Item No.:0124043 - set 10 pc./ bag

Item No.:0124046 - set 5 pc./ bag **I**

tem No.:0124044 - 1 pc. loosely packed

Description:

Pins hinge - 3 mm D.

Material : reinforced Nylon. Extreme strong.

Item No.:0124041 - set 10 pc./ bag

Item No.:0124045 - set 5 pc./ bag

Item No.:0124042 - 1 pc. loosely packed

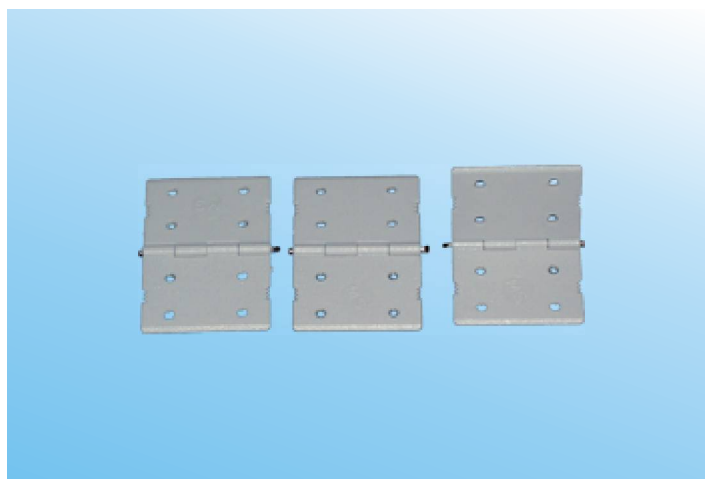

Description:

Pins hinges 25 mm assembled

Material : reinforced Nylon. Extreme strong for giant planes.

Item No.:0124024

set 10 pc./bag

Item No.:0124028

1 pc./loose

Description:

Nylon pins hinges 18 mm

Item No.:0124021 - 10 pc./ bag

Item No.:0124025 - 1 pc/ loose



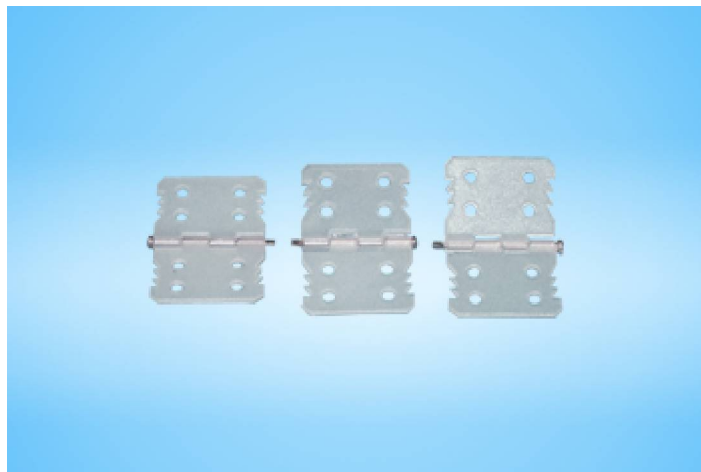

Description:

Nylon pins hinges 15 mm

Item No.: 0124022 - set 10 pc/ bag

Item No.: 0124027 - 1 pc / loose



Description:

Nylon hinges

Item No.:0124023 8 pc/bag

Item No.:0124027 1 pc/ loose

HARDWARE



Description:

Nylon screw M 3x25

Item No.: 0124652 - 10 pc./ bag
0124651 - 1 pc/loose



Description:

Nylon screw M 4x25

Item No.: 0124644 - 10 pc./ bag
0124647 - 1 pc/loose



Description:

Nylon screw M 5x40

Item No.: 0124640 - 10 pc./ bag
0124648 - 1 pc/loose

Description:

Nylon screw M 6x30

Item No.: 0124655 - 10 pc./ bag
0124657 - 1 pc/loosed

Description:

Nylon screw M 6x40

Item No.: 0124646 - 10 pc./ bag
0124649 - 1 pc/loose

Description:

Nylon screw M 6x50

Item No.: 0124654 - 10 pc./ bag
0124656 - 1 pc/loose

Description:

Nylon screw M 6x70

Item No.: 0124653 - 10 pc./ bag
0124650 - 1 pc/loose

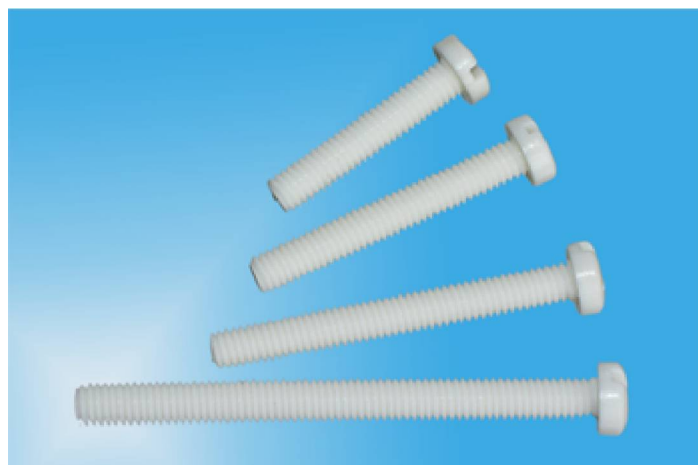

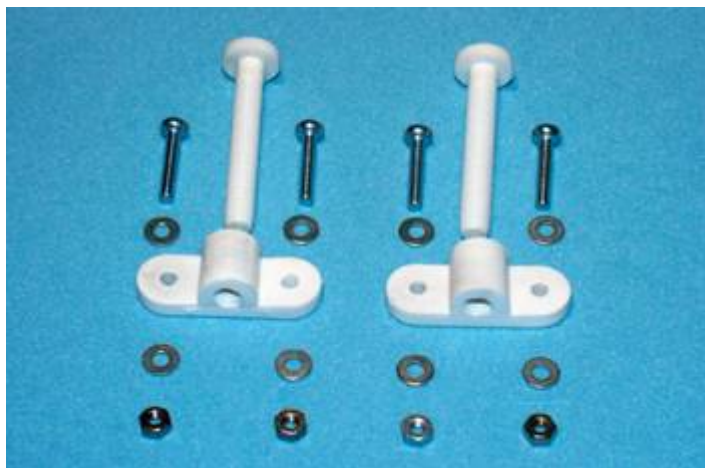

Description:

Wing - mount bolt set M5 incl. mont. hardware

Item No.:0124642 2 sets/bag

Description:

Wing - mount bolt set M6 incl. mount. hardware

Item No.:0124643 2 sets/bag

Description:

Bearing block for 4 mm Dia
set with Mount. Hardware

Item No.:0124330 1 sets/bag

Item No.:0124332 Nylon part only 1 pc/loose

Description:

Bearing block for 3.15 mm Dia
set with Mount. Hardware

Item No.:0124331 1 sets/bag

Item No.:0124333 Nylon part only 1 pc/loose



Description:

Nylon bolt W Hand Nut M6

Item No.:0124537 10 pc./bag

Item No.:0124536 1 pc./loose

Nylon bolt W Hand Nut M

Item No.:0124538 10 pc./bag

Item No.:0124535 1 pc./loose

Nylon bolt W Hand Nut M4

Item No.:0124545 10 pc./bag

Item No.:0124534 1 pc./loose

Nylon bolt W Hand Nut M3

Item No.:0124539 10 pc./bag

Item No.:0124540 1 pc./loose

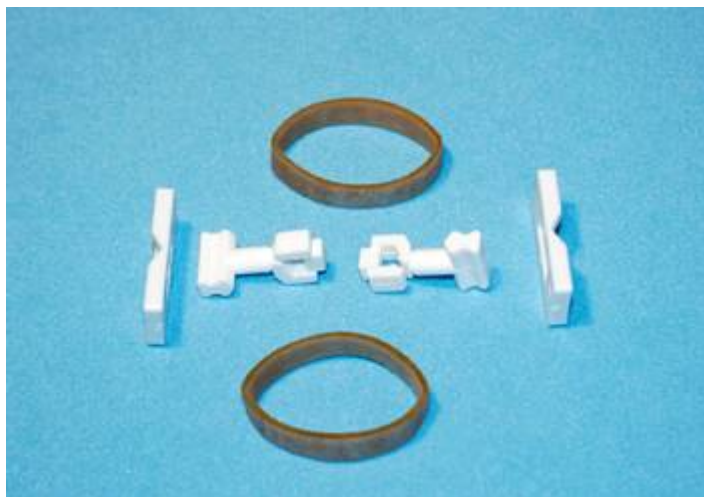

Description:
Wing Retainer for Sailplane

Item No.:0123500 1set/bag

Description:

- Blind nuts M3
Item No.: 0215300 1 pc/loose
- Blind nuts M4
Item No.: 0215400 1 pc/loose
- Blind nuts M5
Item No.: 0215500 1 pc/loose
- Blind nuts M6
Item No.: 0215600 1 pc/loose



Description:

- Metric nyloc hex nut M2
Item No.:0215202 1 pc/lose
- Item No.:**0215212 10 pc/bag
- Metric nyloc hex nut M3
Item No.: 0215203 1 pc/lose
- Item No.:**0215213 10 pc/bag
- Metric nyloc hex nut M4
Item No.: 0215204 1 pc/lose
- Item No.:**0215214 10 pc/bag
- Metric nyloc hex nut M5
Item No.: 0215205 1 pc/lose
- Item No.:**0215215 10 pc/bag



Description:

- Steering arm dia. 2,0 **Ord. Nr.:** 0233200 1pc/lose
- Steering arm dia. 2.1 **Ord. Nr.:** 0233201 1pc/lose
- Steering arm dia. 3.1 **Ord. Nr.:**0233301 1pc/lose
- Steering arm dia. 4.1 **Ord. Nr.:** 0233401 1pc/lose

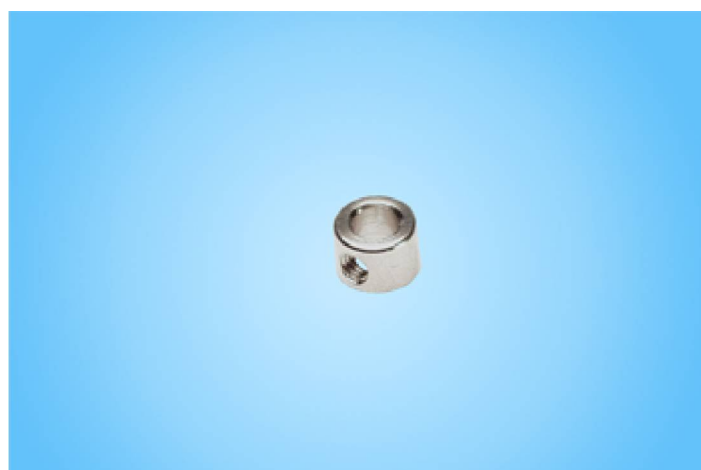

LATCHES



Description:

Hatch latch

Body is very strong plastic, metal parts are rustproof steel, very easy to mount.

Item No.: 0124827 - 1 pc/ bag

Item No.: 0124826 - 1 pc - lose

Description:

Hatch latch - metal. Outline size 31 mm
Brass housing 5 mm Dia. Spring loaded steel pin 3 mm Dia. Outline length 31, Mounting size 19 mm

Item No.: 0124828 - 1 pc - lose

Item No.: 0124830 - 1 pc/ bag

Description:

Hatch latch - metal. Outline size 25 mm
Brass housing 5 mm Dia. Spring loaded steel pin 3 mm Dia. Outline length 25, Mounting size 16 mm

Item No.: 0124829 - 1 pc - lose

Item No.: 0124831 - 1 pc/ bag



Description:

Nylon Pin's latch

Item No.: 0122300

10 pc./bag

Item No.: 0122301

1 pc./lose

AERO - PROP



Description:

Plastic propeller 7 x 8" for CO 2 motor

Item No.:0124202

1 pc/bag

Description:

Plastic propeller set 7 x 8" for rubber power

Item No.:0124203

1 set/bag

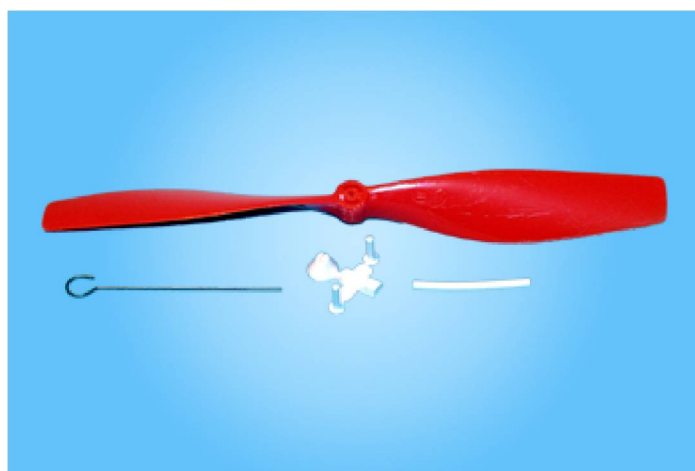

Description:

Set for CO 2

Item No.:0124205

1 set/bag

BOAT - PROP

Description:

Boat propeller: 30mm Dia. Thread M3

Item No.:0123010 2 pc/bag

Item No.:0123013 1 pc/loose

Description:

Boat propeller: 40mm Dia. Thread M3

Item No.:0123011 2 pc/bag

Item No.:0123014 1 pc/loose

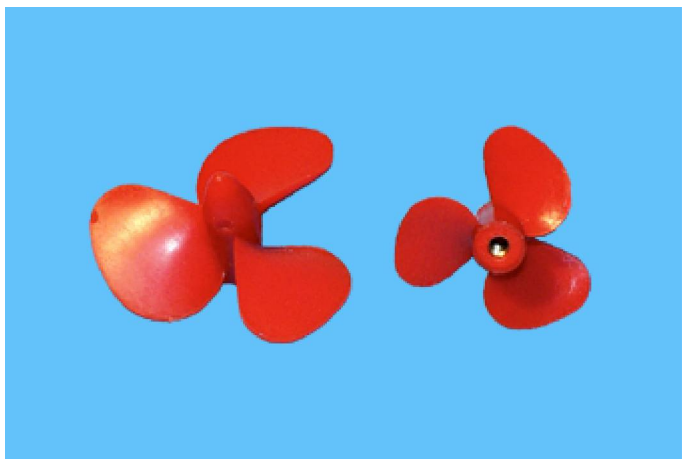

Description:

Boat propeller Dia. 30mm two blades
version

Item No.:012312 2 pc/bag

Item No.:012315 1 pc/loose

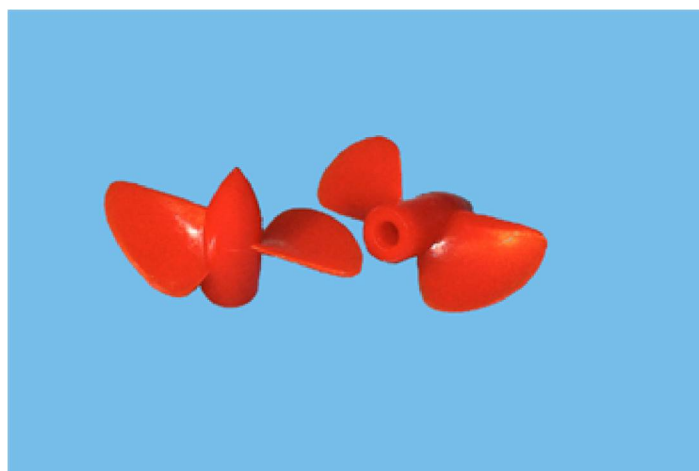

SPINNERS



Description:
Plastic spinner Dia. 35mm with
profile Hex nut M6

Item No.:0123450 1 set/bag

Description:
Plastic spinner for CO₂ engine

Item No.:0123457 1 set/bag

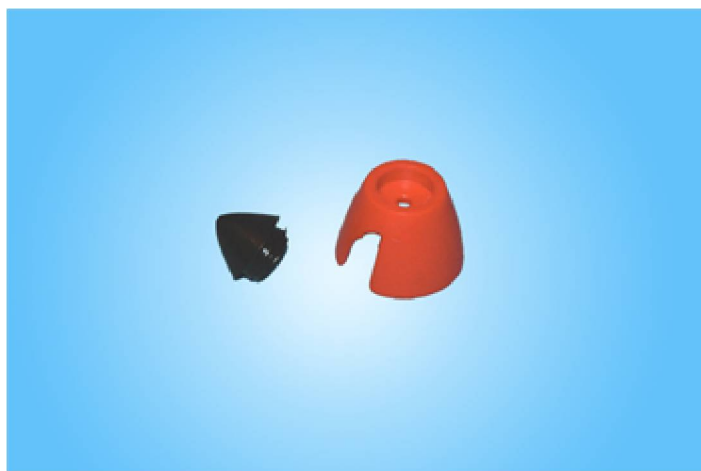

Description:
Plastic spinner Dia. 35

Item No.:0123449 1 set/bag



Description:
Plastic spinner for Dia. 60

Item No.:0123460 1 pc/bag





Description:
Plastic spinner Dia. 45

Item No.:0123451 1 set/bag

Description:
Plastic spinner Dia. 45mm
with profile Hex nut M6

Item No.:0123452 1 set/bag



Description:
Plastic spinner Dia. 60

Item No.:0123453 1 set/bag

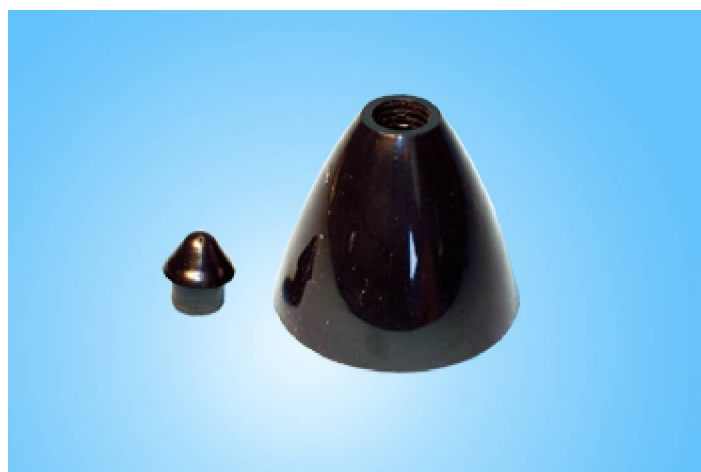

Description:
Plastic spinner Dia. 35mm
with profile Hex nut M4 and bolt

Item No.:0123454 1 set/bag





Description:
Plastic spinner dia. 35mm with
profile Hex nut M5 and bolt

Item No.:0123455 1 set/bag

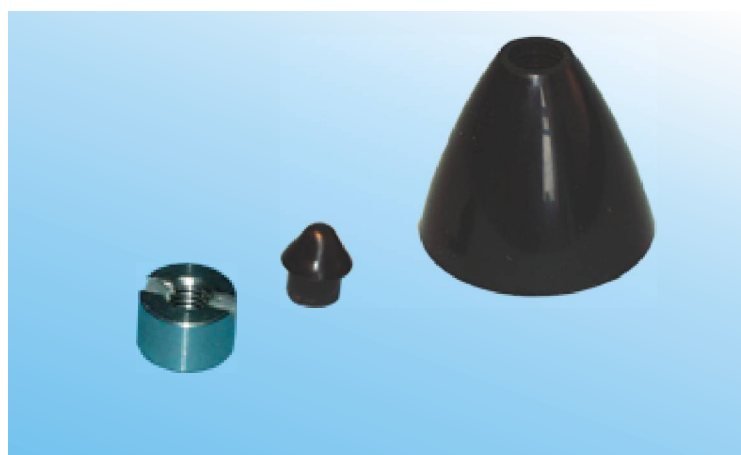

Description:
Plastic spinner Dia. 60mm
with profile Hex nut M6

Item No.: 0123456 1 set/bag

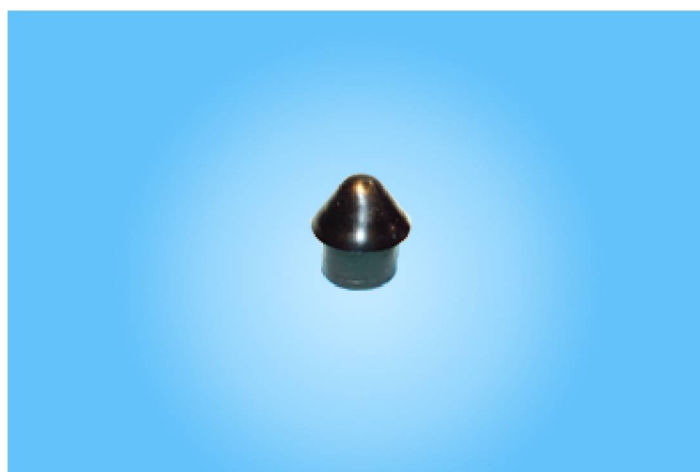

Description:
Plastic cork spinner for Dia. 45 and
60mm

Item No.:0123459 1 pc/bag

Description:
Plastic spinner Dia. 45

Item No.:0123458 1 pc/bag



WHEELS, UNDERCARRIAGE

Description:

Wheel Dia. 30mm - pair
Plastic, Extra light.

Item No.:0122102 2 pair+tail wheel/bag

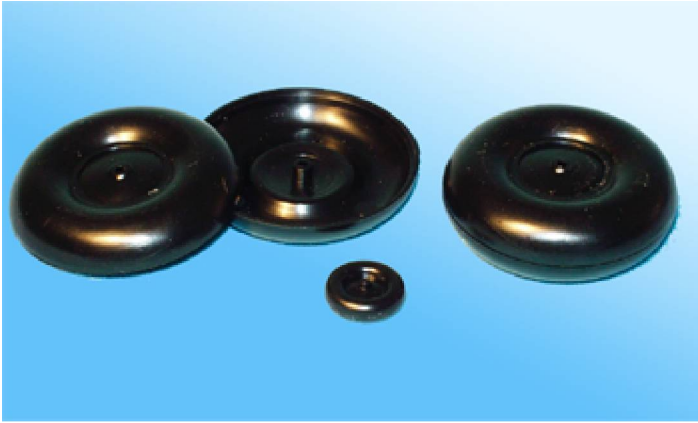

Description:

Wheel Dia. 40 mm
Plastic, Extra light.

Item No.:0122103 2 pc/bag

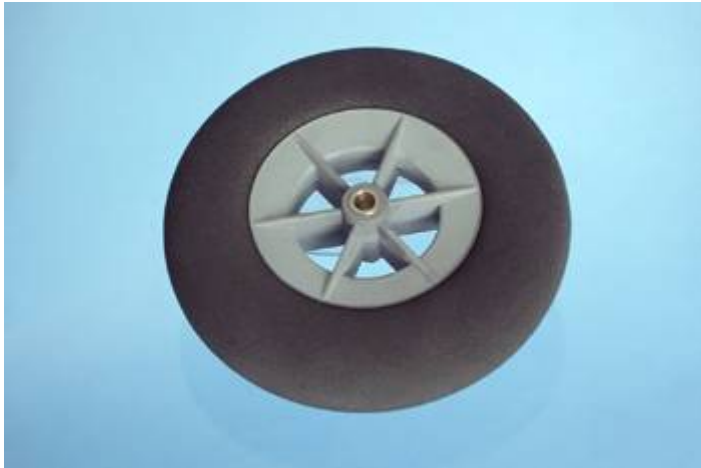

Description:

Aluu Wheel Dia. 150mm, Weight 136 gr. only
Designed for giant planes

- Item No.:**0227101 - 120 mm dia 1pc
- Item No.:**0227150 - 150 mm dia 1pc
- Item No.:**0227180 - 180 mm dia 1pc

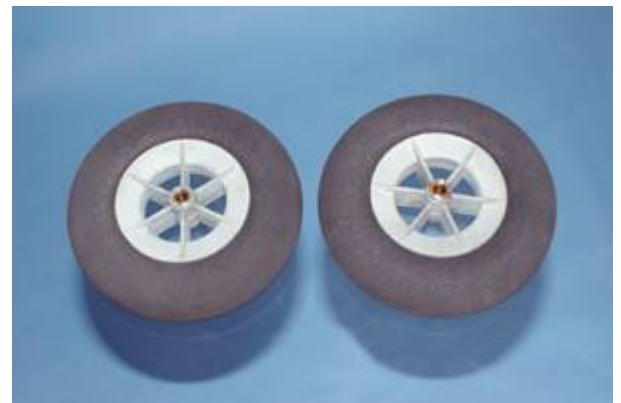

Description:

Tail undercarriage
Designed for giant planes

Order Nr

:022606 - Tail Undercarriage - up to 6 kg planes
double spring 1 pc/bag

022607 Tail Undercarriage - up to 4 kg planes
Material - Spring's steel

1 pc/bag

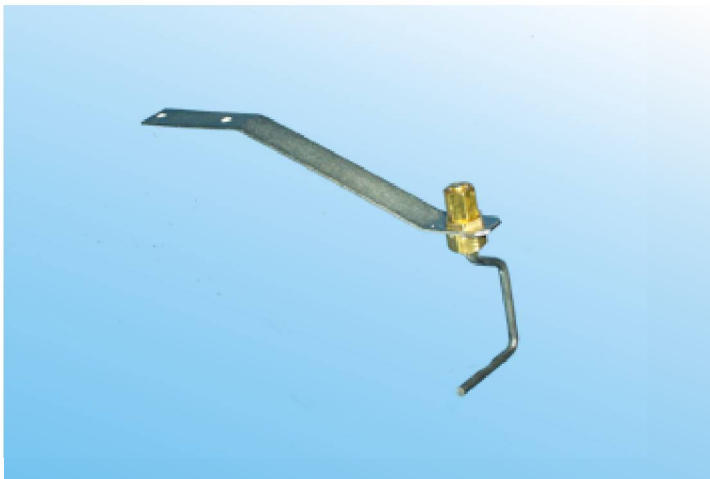

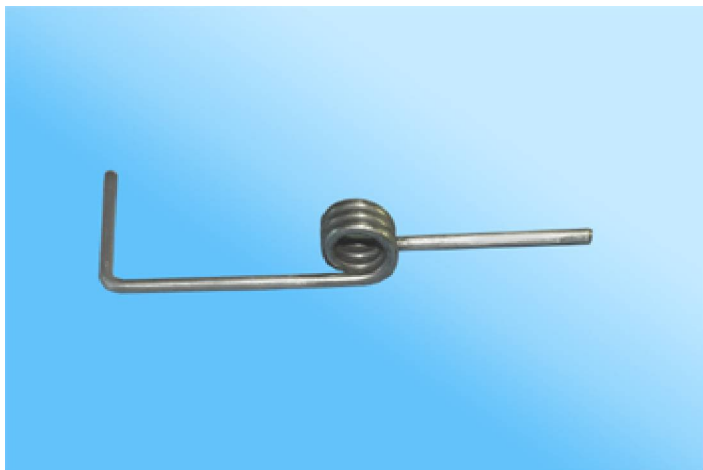

Description:
Nose gear

Item No.: 0226000

Description:
Wire for rear gear

Item No.:0226010

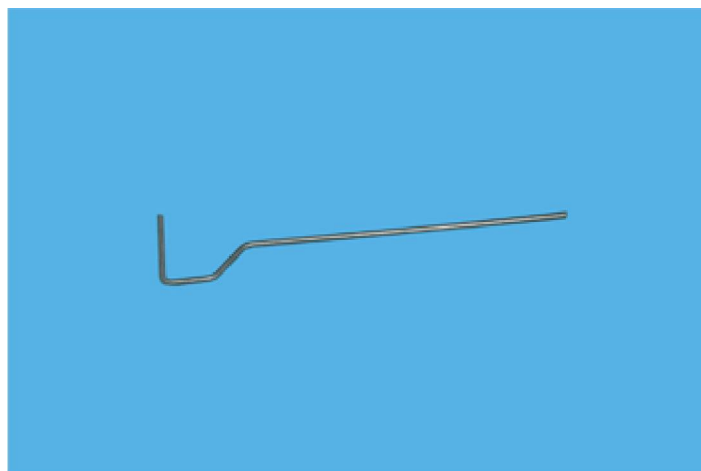

Description:
Tail undercarriage
Designed for scale plane, for plane up to
15 kg

Item No.:3051103 1 pc

Description:
Mainl undercarriage
Designed for scale plane, for plane up to
15 kg

Item No.:3051102 1 pair



NYLON RIBS

Ideal for beginners

Suitable for planes like handlaunch

Description:

Ribs for tapered wing chord 205,200,195 ...150 mm. Suitable for RC gliders. Match to ribs Item No.0124133. Wing ribs 0124133 and 0124134 are available for balsa-sheet covered wing nose section and strip - reinforcement of ribs. Slotfor strip 5 x 3 mm. Weight 1,0-1,7 gr/pc. x 6 pc./set

Item No.:0124134

1 set/bag

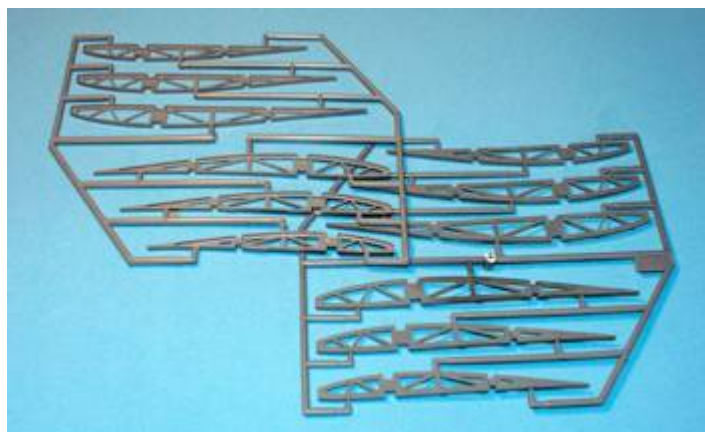

Description:

Wing chord 112 mm. Suitable for glider - competitive class A1, A3. Weight 0,5 gr./pc
2 x 12 pc./set

Item No.:0124135

set/bag

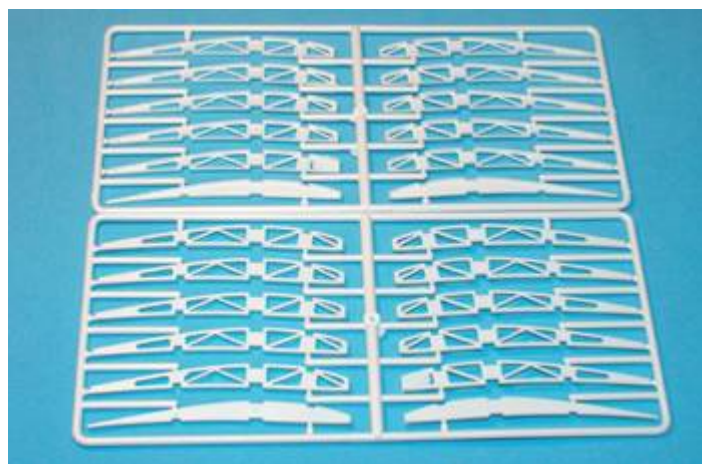

Description:

Ribs for tapered wing chord 2 x 12 pc. Ribs for wing chord 112 mm & set for tapered panels - 2 pc./each - 103mm, 94mm, 85 mm. Weight 0,4-0,6 gr/pc

Item No.:0124136

1 set/bag



Description:

Ribs for wing chord 70 mm
Sturdy nylon ribs for handlaunch glider. Weight 0,2gr/pc
2 x 10 pc./set

Item No.:0124137

2 x 10 pc./set/bag

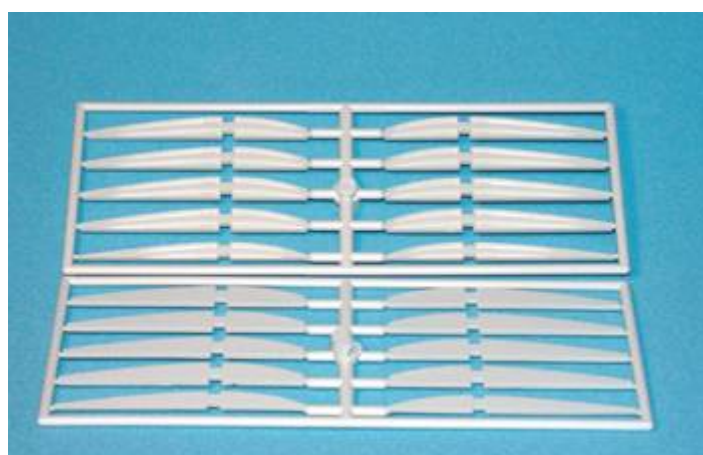



Description:

Ribs for wing chord 110 mm Sturdy nylon
airfoil E 387, Wing chord 110 mm. Most suitable for
training glider and plane with CO2 propulsion. Slot for
strip 3x5 mm. Weight 1,2 gr/pc
2 x 12 pc./set

Item No.:0124130

2 x 12 pc./set/bag

Description:

Ribs for wing chord 100 mm
Sturdy nylon airfoil E 387, Wing chord 100 mm.
Most suitable for plane with CO2 propulsion. Weight
0,4 gr./Psc.
2 x 12 pc./set

Item No.:0124132

2 x 12 pc./set/bag

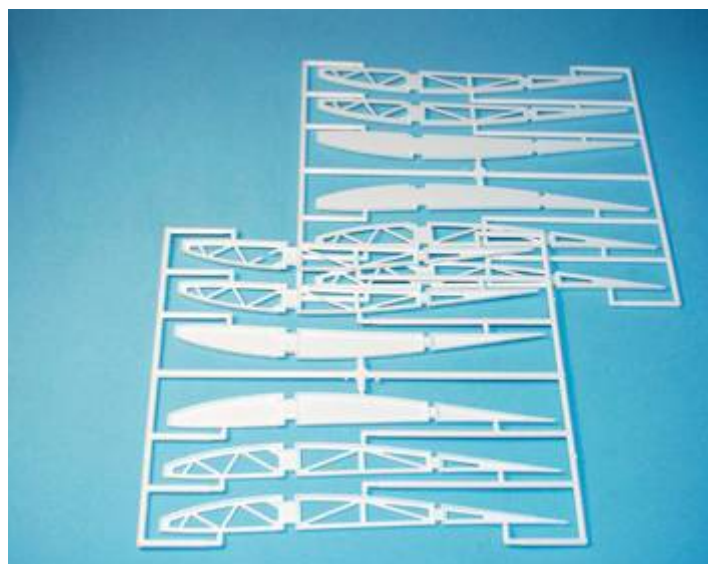
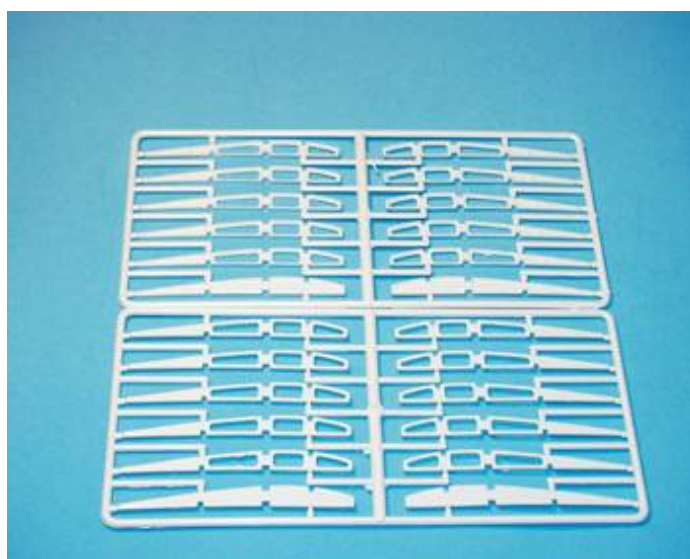

Description:

Ribs for wing chord 210 mm
Sturdy nylon airfoil E 387, Wing chord 210 mm. Most
suitable for RC gliders.
Weight 2,5 gr/pc.
4 x 6 pc./set

Item No.:0124133

4 x 6 pc./set/bag

TOWING HARDWARE



Description:

Parachute - diameter 40 cm.

Item No. 0426310 1 pc/bag

Description:

Machined metal joiners for Sailplane Hi-Start.

Item No.

0232010	Hi start joiners set dia. 8.5/5	1 Set/bag
0232020	Hi start joiners set dia. 8.5/6	1 Set/bag
0232000	Hi start joiners set dia. 8.0/6	1 Set/bag
0232030	Hi start joiners set dia. 9.5/6	1 Set/bag



POWER CONNECTORS

Strong body and contact

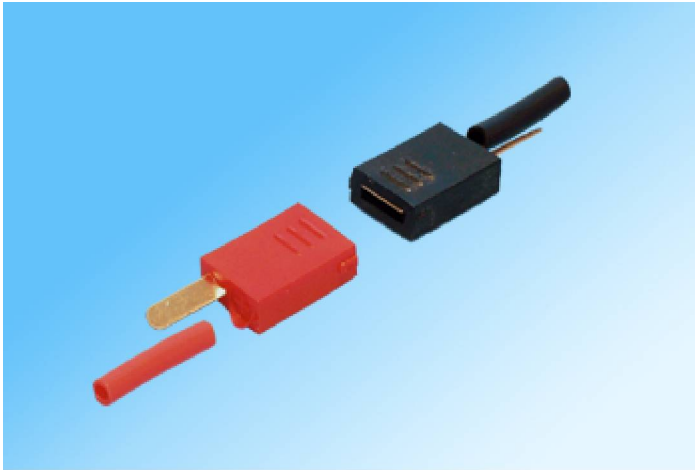

Description:

Battery connectors

Item No.:0125100

1 pair/bag

Description:

Connector set 2 pole
/set Male - Female

Item No.:0125207

1 pair/bag

Item No.:0125205

1 pc/loose

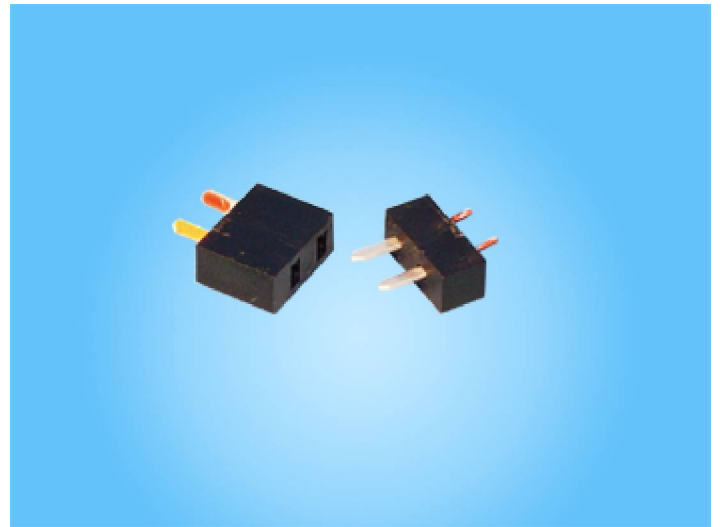

Description:

Contact connector set 4 pole
/set Male - Female

Item No.:0125202

1 pair/bag

Item No.:0125201

1 pc/loose



Description:

Connector set 5 pole
set Male - Female

Item No.:0125208

1 pair/bag

Item No.:0125209

1 pc/loose





Description:

Connector set 8 pole
/set Male - Female

Item No.:0125203

1 pair/bag

Item No.:0125204

1 pc/loose

 [HOME](#)

CONTROL - LINES HW.



Description:

Elevator Installation Set for C/L plane
incl. all hardware.

Item No.:0123120

1 set/bag

Description:

C/L - control handle incl. hardware

Item No.:0120060 1 set/bag

 [HOME](#)



ENGINE MOUNT HW



Description:

All-purpose el. motor's mount
- fiberglass

Item No.:0123330 1 Skt./lose
Item No.:0123326 1 Skt./Bag

Description:

Motor mount for Speed 600, Phasor, Actro
Outline Dia. 13 mm. inside Dia. 39 mm
Fiberglass 2 mm

Item No.:

0123325 - 1 pc. / bag
0123329 - 1 pc./ loose

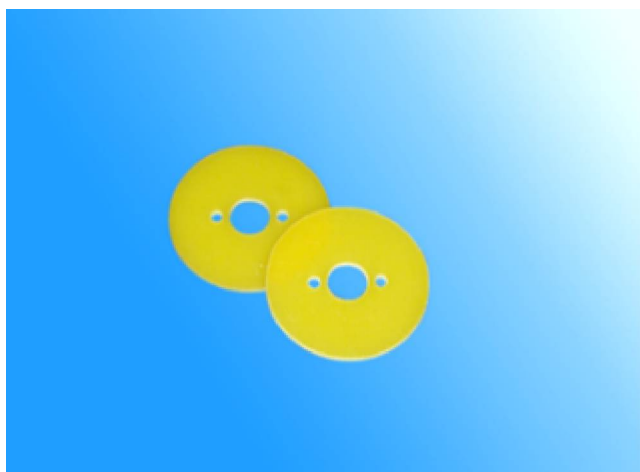
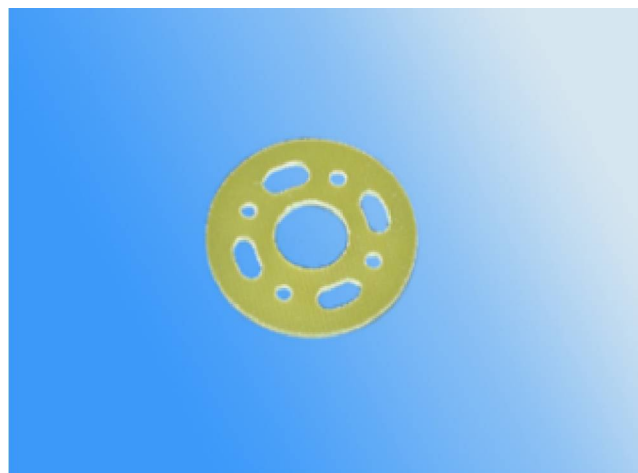

Description:

Motor mount for Speed 400,
Outline Dia. 10 mm , inside Dia 39 mm
Fiberglass 2 mm

Item No.:

0123324 - 1 pc../ bag
0123328 - 1 pc../ loose

Description:

Motor mount for Speed 400
Outline Dia. 10 mm , inside Dia. 28 mm
Fiberglass 2 mm

Item No.:

0123323 - 1 pc/ bag
0123327 - 1 pc../ loose

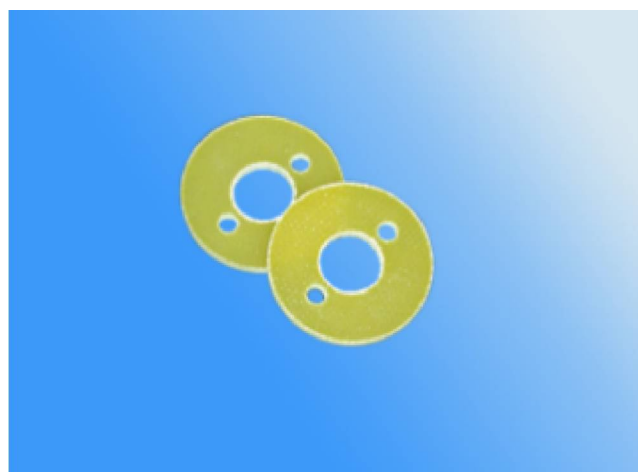

ENGINE MOUNT HW

Description:

Plastic engine mount "20" Size
with mounting hardware

Item No.:0123331 1 set/bag

Description:

Plastic engine mount "40" Size
with mounting hardware

ItemNo.:0123332 1 set/bag

Body is strong plastic, reinforced by glass



Description:

Dural engine mount "20"
- with nose gear peg

Item No. 0218000

FUEL TANK, PUMP, HW



Description:

Complete set for tank armature - gas 1set/bag
 - Nickel coated. Inside Dia.3,2mm
 1xclunker incl.filter+1x pressure fitting halves+1xdouble pressure fitting+ 2xwasher+ 2x hex nut M5/bag

- Item No.:**0240006 Pressure fitting - set for gas 1 Set/bag
- Item No.:**0240007 Pressure fitting - set for gas 5 Set/bag
- Item No.:**0240008 Double pressure fitting - for gas 1 Set/bag
- Item No.:**0240009 Double pressure fitting - for gas 5Set/bag

Description:

Fuel clunker incl. filter - metal
 - Nickel coated.

- Item No.:**0240003 - 1 pc - loose
- Item No.:**0240004 - 1 pc / bag



Description:

Fuel filter 3 layer's

- Item No.:**0123231 1 pc./loose
- Item No.:**0123230 1 pc./bag

Description:

Hand fuel pump
Item No.:0123232 1 pc./bag





Description:
Garniture of fuel tank
- Nickel coated.

Item No. : 0240001 1pc/loose
Item No.: 0240011 1pc/bag

Description:
Joiners for fuel tubing M5
- Nickel coated., Inside 2,1 Dia.

Item No.: 0232500 1pc/loose
Item No.: 023501 1pc/bag



Description:
Fuel line fitting „clunker“ fuel pickup
- Nickel coated
two version - Inside 2,1 Dia, 3,2 Dia

Item No.: 0240000 1pc/loose
Item No.: 0240010 1pc/bag

 [HOME](#)

Description:
Fuel tank 35 ccm set

Item No.: 0124901 1 set/bag



BATTERY COMPARTMENTS



Description:

Battery case for AE size for 2 cell

Black colour plastic 0,97mm thickness

Item No. 0426120

1 pair/loose

Item No.: 0426121

1 pair /bag

Description:

Battery case for AE size for 4 cell

Black colour plastic 0,97mm thickness

Item No.: 0426130

1 pair/loose

Item No.: 0426131

1 pair /bag



SURFACE SERVO COVERS



Description:

Ailerons servo cover 80 x 53 x 8 mm

White colour plastic 0,97 mm thickness, pair

Item No.: 0426210 1 pc/loose
Item No.: 0426111 1 pc /bag

Description:

Surface ailerons servo cover 80 x 62 mm

White colour plastic 0,97 mm thickness, pair

Item No.: 0426220 1 pc/loose
Item No.: 0426121 1 pc /bag

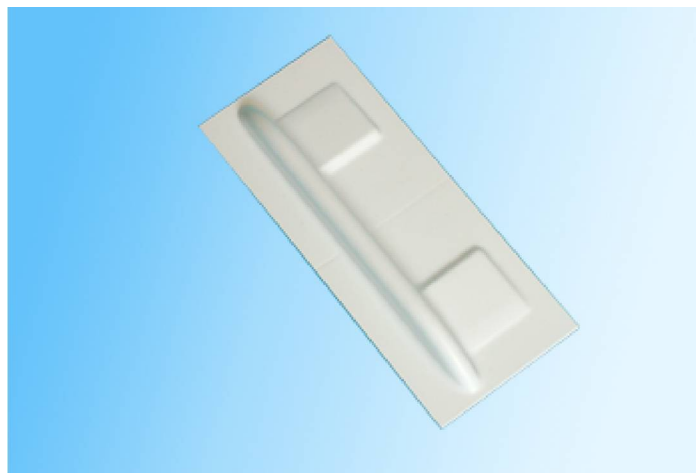

Description:

Surface mounts for mini servo, pair

White colour plastic 0,97 mm thickness

Item No.: 0426230 1 pc/loose
Item No.: 0426131 1 pc /bag



Description:

Surface servo cover 61 x 70 mm

White colour plastic 0,97 mm thickness, pair

Item No.: 0426200 1 pc/loose
Item No.: 0426201 1 pc /bag

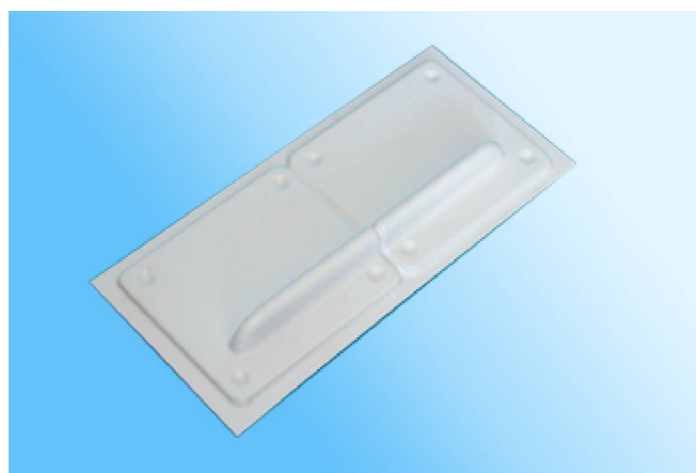

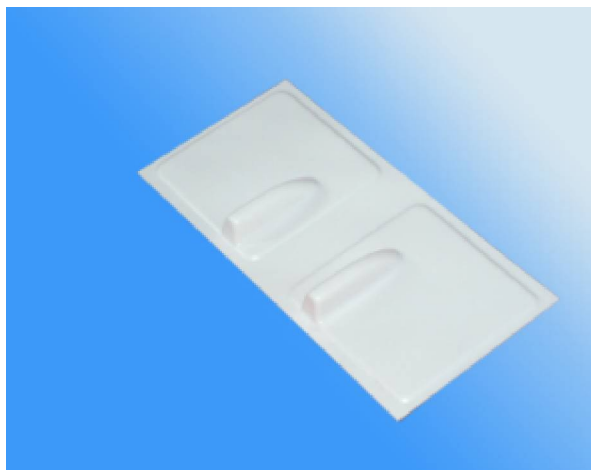

Description:

Surface servo cover 60 x 60 mm

White colour plastic 0,90 mm thickness, pair

Item No.: 0426215 1 pc/loose

Item No.: 0426116 1 pc /bag



Description:

Servoschacht - inside Dia. 34 mm, Outside 35,5 mm,
Deep 14 mm

White colour plastic 0,97 mm thickness, pair

Item No.: 0426240 1 pc/loose

Item No.: 0426239 1 pc /bag

The servoschacht are delivery lossely packed - bulk usually
Packaging per 1 or 2 pc to bag is possible for concrete order
Is possible also thickness of material 0,3 mm, 0,5 mm, 0,7mm, 1,0 mm

Description:

Sevocabel flex canal, transparent
available for Futaba, MPX, Graupner conectors

Item No.: 0402500 1 m - (3 m length max.)

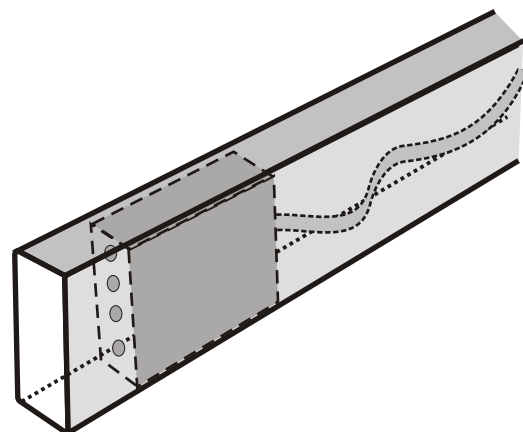

TRANSMITTER'S TRAY



Description: Transmitter tray
Black colour robust plastic mould.
Thickness 1 mm

Inner dimension : 185 x 50 mm

All claps, variable textile belt and other hardware included.

Item No. 0426300

Transmitter tray for Hitec line - RD 6000, Skysport, Flash 5, VG 400, VG 600. Komplete set include - stabil and strong tray, beld, clips and small HW

Item No. 0426301

Transmitter tray for MC 10, MC 12 size. Komplete set include - stabil and strong tray, beld, clips and komplete HW

TOOLS



Description:

Modeling pins

50 pc./box

Item No.:0120002

Very narrow shaft and long taper point to prevent wood splitting. The metal shafts are bent 90 degrees inside the plastic so they can not pull out. The plastic end is convex to protect to hurt.

Description:

Extension for tube

Item No.:0120010

2 pc/bag

Item No.: 0120010

1 pc / loose



[HOME](#)

PILOT BUSTS



Material : Styropor
 Colour: nature - white
 Size and weight may varying in tolerance +/- 5 %

Order number : 0425101	1 pc/loose
Order number : 0425101/B	1 pc/lbag
Scale	1:4
Height/mm	117
Breadth/mm	86
Weight/ gr.	32,8

Order number : 0425100	1 pc/loose
Order number : 0425100/B	1 pc/lbag
Scale	1:4
Height/mm	119
Breadth/mm	101,5
Weight/ gr.	53,5 gr.

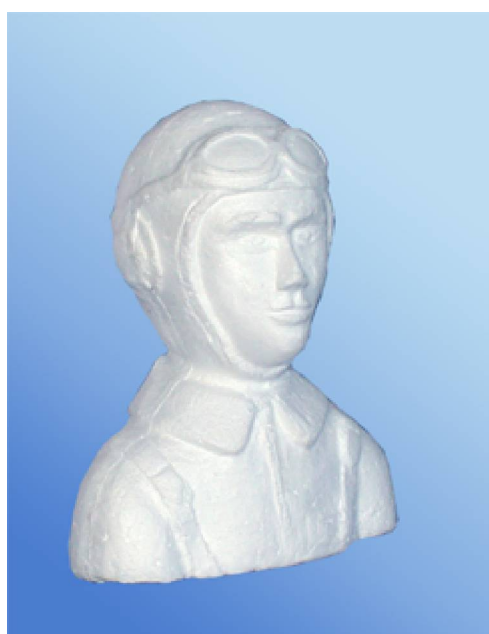

Order number : 0425200	1 pc/loose
Order number : 0425200/B	1 pc/lbag
Scale	1:6
Height/mm	91
Breadth/mm	78
Weight/ gr.	18,7



Order number : 0425300/1
Order number : 0425300/1/B
 Scale
 Height/mm
 Breadth/mm
 Weight/ gr.

1 pc/loose
 1 pc/lbag
 1:8
 51
 47
 6,5

Order number : 0425300/2
Order number : 0425300/2/B
 Scale
 Height/mm
 Breadth/mm
 Weight/ gr.

1 pc/loose
 1 pc/lbag

1:8
 54
 48
 8,4



Order number : 0425301
Order number : 0425301/B
 Scale
 Height/mm
 Breadth/mm
 Weight/ gr.

1 pc/loose
 1 pc/lbag

1:8
 53
 55
 9,7

Order number : 0425302
Order number : 0425302/B
 Scale
 Height/mm
 Breadth/mm
 Weight/ gr.

1 pc/loose
 1 pc/lbag

1:8
 74
 65
 7,3





Order number : 0425303
Order number : 0425303/B
Scale
Height/mm
Breadth/mm
Weight/ gr.

1 pc/loose
1 pc/lbag
1:8
62
65
7,8

Order number : 0425304
Order number : 0425304/B
Scale
Height/mm
Breadth/mm
Weight/ gr.

1 pc/loose
1 pc/lbag



NEXT 



Order number : 0425400
Order number : 0425400/B
Scale
Height/mm
Breadth/mm
Weight/ gr.

1 pc/loose
1 pc/lbag
1:10
40
42
3,2

Order number : 0425401
Order number : 0425401/B
Scale
Height/mm
Breadth/mm
Weight/ gr.

1 pc/loose
1 pc/lbag
1:10
44
44
3,9



Order number : 0425402
Order number : 0425402/B
Scale
Height/mm
Breadth/mm
Weight/ gr.

1 pc/loose
1 pc/lbag
1:10
45
44
3,9



WOOD PRODUCTION

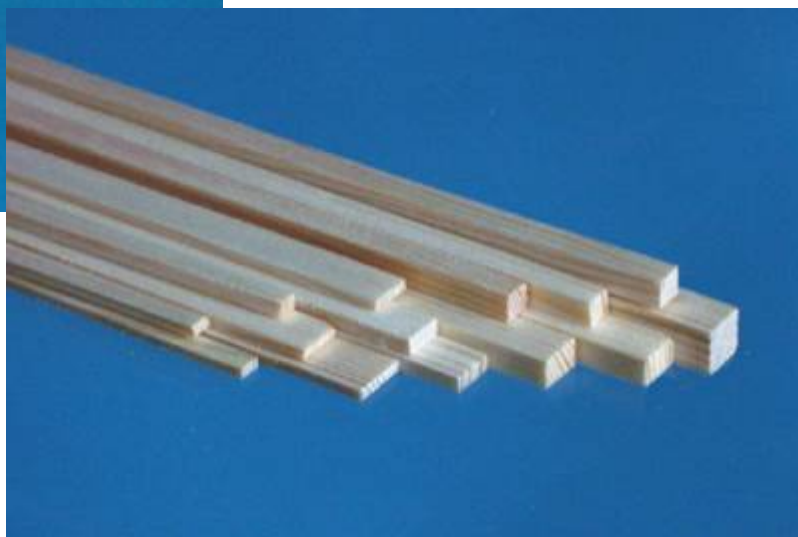

Short intro to our production capabilities:

- all sortiment of balsa sheets, struts, leading, trailing edges.
- lime airfoil, struts
- struts made from Swedish pine wood excellent quality.

Design and production of models of planes.

Full guarantee of production incl. printing of instruction, labels, decals, carefully package available for post sending.

Complete documentation of projects.

Our technologic possibilities include CNC machining, DTP preparing, preparing of moulds for plastic and fiberglass production,
Vacuum forming.

For more info contact us per e-mail or by phone

info@modellstudio.cz

00420 572597161



[HOME](#)